



DMP 320

Precision Pressure Transmitter with Fast Response Time

Stainless steel sensor

accuracy according to IEC 60770:
0.1% FSO

Nominal pressure

from 0...100 mbar up to 0...600 bar

Output signal

3-wire: 0.1 ... 10 V
4 ... 20 mA

others on request

Product characteristics

- ▶ extremely fast response time ≤ 0.5 ms
- ▶ internal sample rate 10 kHz
- ▶ accuracy 0.1% FSO
- ▶ excellent thermal behaviour
- ▶ outstanding long term stability

optional versions

- ▶ customer specific versions

DMP 320 stands for speed and precision.

With a response time of ≤ 0.5 msec and a sampling rate of 10 kHz, the pressure transmitter was designed for applications, in which an extremely fast and exact pressure measuring is required. Pressure curves, peaks and hits can be monitored and evaluated exactly.

The signal processing of the sensor signal is done by newly developed digital electronics, which detect the signal with a sampling rate of 10 kHz. Sensor-specific deviations such as non-linearity, hysteresis and temperature errors are compensated actively.

Preferred areas of use are



Plant and Machine Engineering



Energy Industry



DMP 320

Industrial Pressure Transmitter

Technical Data

Input pressure range												
Nominal pressure gauge	[bar]	-1...0	0.10	0.16	0.25	0.40	0.60	1	1.6	2.5	4	6
Nominal pressure abs.	[bar]	-	-	-	-	0.40	0.60	1	1.6	2.5	4	6
Overpressure	[bar]	5	0.5	1	1	2	5	5	10	10	20	40
Burst pressure \geq	[bar]	7.5	1.5	1.5	1.5	3	7.5	7.5	15	15	25	50

Nominal pressure gauge / abs	[bar]	10	16	25	40	60	100	160	250	400	600
Overpressure	[bar]	40	80	80	105	210	600	600	1000	1000	1000
Burst pressure \geq	[bar]	50	120	120	210	420	1000	1000	1250	1250	1250
Vacuum resistance		$P_N \geq 1$ bar: unlimited vacuum resistance $P_N < 1$ bar: on request									

Output signal / Supply	
3-wire	0.1 ... 10 V / $V_S = 14 ... 30 V_{DC}$
3-wire	4 ... 20 mA / $V_S = 14 ... 30 V_{DC}$

Performance	
Accuracy ¹	$\leq \pm 0.1$ % FSO
Permissible load	Current 3-wire: $R_{max} = 500 \Omega$ Voltage 3-wire: $R_{min} = 10 k\Omega$
Influence effects	supply: 0.05 % FSO / 10 V load: 0.05 % FSO / $k\Omega$
Long term stability	$\leq \pm 0.1$ % FSO / year
Response time	≤ 0.5 ms

¹ accuracy according to IEC 60770 – limit point adjustment (non-linearity, hysteresis, repeatability)

Thermal effects (Offset and Span) / Permissible temperatures	
Tolerance band [% FSO]	$\leq \pm 0.2$ in compensated range -20 ... 80 °C
TC, average [% FSO / 10 K]	± 0.02 in compensated range -20 ... 80 °C
Permissible temperatures	medium: -40 ... 125°C electronics / environment: -40 ... 85°C storage: -40 ... 100°C

Electrical protection	
Short-circuit protection	permanent
Reverse polarity protection	no damage, but also no function
Electromagnetic compatibility	Emission and immunity according to EN 61326

Mechanical stability	
Vibration	10 g RMS (25 ... 2000 Hz) nach DIN EN 60068-2-6
Shock	500 g / 1 ms nach DIN EN 60068-2-27

Materials	
Pressure Port	stainless steel 1.4404
Housing	stainless steel 1.4404
Option compact field housing	stainless steel 1.4305, cable gland M12x1,5, brass, nickel plated others on request
Seals (media wetted)	standard: FKM options: EPDM others on request
Diaphragm	Stainless steel 1.4435
Media wetted parts	Pressure port, seal, diaphragm

Miscellaneous	
Current consumption	Signal output current: max. 25 mA
Weight	approx. 200 g
Installation position	any ²
Operational life	$> 100 \times 10^6$ pressure cycles
CE-conformity	EMV-Directive: 2004/108/EG

² Pressure transmitters are calibrated in a vertical position with the pressure connection down. If this position is changed on installation there can be slight deviations in the zero point for pressure ranges $P_N \leq 1$ bar.

Wiring diagrams	Pin configuration					
3-wire-system (current/voltage) 	Electrical connection	ISO 4400	Binder 723 (5-pin)	M12x1/metal (4-pin)	Field housing	cable colours (DIN 47100)
	Supply +	1	3	1	IN +	wh (white)
	Supply -	2	4	2	IN -	bn (brown)
	Signal +	3	1	3	OUT +	gn (green)
Shield	Ground pin	5	4			ye/gn (yellow/green)

DMP 320

Industrial Pressure Transmitter

Technical Data

Electrical connections (dimensions in mm)

Standard

Optional

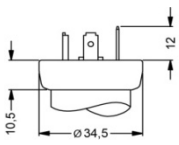

ISO 4400
(IP65)

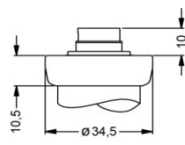

Binder Serie 723
5-pin
(IP67)

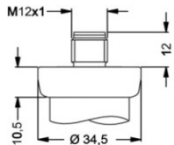

M12x1, 4-pin
(IP67)

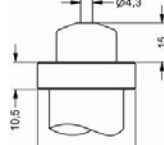

Cable outlet with
PVC cable
(IP67)³

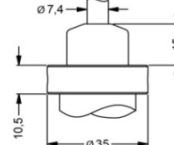

Cable outlet, cable
with ventilation tube
(IP68)⁴

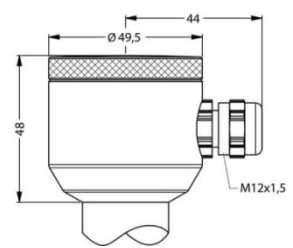

Compact field housing
(IP 67)

⇒ universal field housing stainless steel 1.4404 with cable gland M20x1,5 (ordering code 880) and other versions on request

³ standard: 2 m PVC-cable without ventilation tube (permissible temperature: -5 ... 70°C)

⁴ different cable types and lengths available, permissible temperature depends on kind of cable

Mechanical connections (dimensions in mm)

Standard

Optional

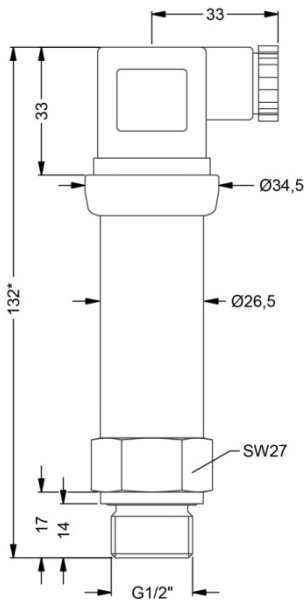

G1/2" DIN 3852
with ISO 4400

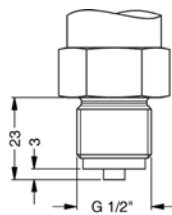

G1/2" EN 837

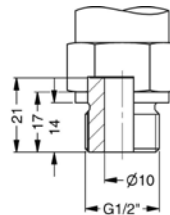

G1/2" open
port, P_N ≤ 40

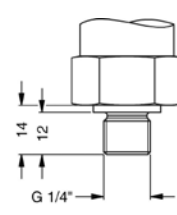

G1/4" DIN 3852

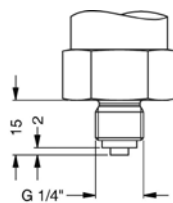

G1/4" EN 837

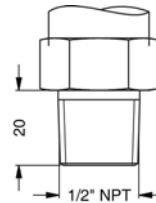

1/2" NPT

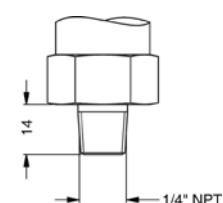

1/4" NPT

⇒ metric threads and other versions on request

⇒ * for nominal pressure P_N > 40 bar increases the length of devices by 9 mm

This data sheet contains product specification, properties are not guaranteed. Subject to change without notice.

