



TE 118

Temperaturgivare

Användningsområde

TE-118 används för mätning i låga tryckområden, exempelvis luft, ånga eller västkor

Mätinsats

Fast monterad i enlighet med IEC 751

Skyddsror

| | |
|------------------|----------------|
| Enligt DIN 43763 | |
| Diameter | Ø 6 mm |
| Instickslängd | 75 - 400 mm |
| Material | Rostfritt stål |

Anslutningshuvud

| | |
|------------------------------|--------------|
| Utförande B enligt DIN 43729 | |
| Material | Lättmetall |
| Täthetsklass | IP55 |
| Kabelförskruvning | PG 16 |
| Kabeldiameter | Ø 12 - 15 mm |

Reaktionstid

| | | |
|--------|---------|----------------|
| Vatten | 0,4 m/s | t 0,5 = 11 sec |
| Luft | 3,0 m/s | t 0,5 = 35 sec |

OPTION

Konsol BR6.2

| | |
|----------|----------------|
| Material | Rostfritt stål |
|----------|----------------|

Klämringskoppling

| | |
|---------------------|-----------------------|
| Material | Rostfritt stål/teflon |
| Mekanisk anslutning | G ¼" |
| Option | G ½", G ¾" |

Transmitter

| | |
|--------------------------|----------|
| Programmerbart mätområde | |
| Matningsspänning | 8 - 35V |
| Utsignal | 4 - 20mA |

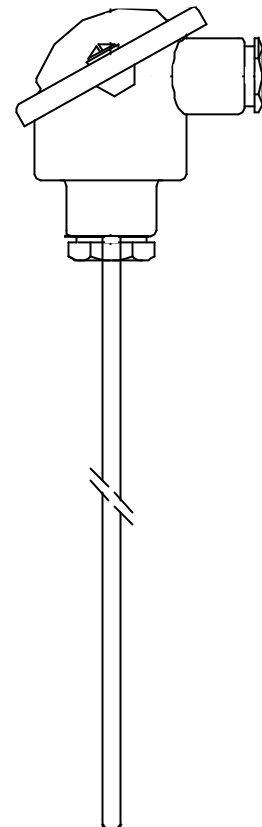

Mått

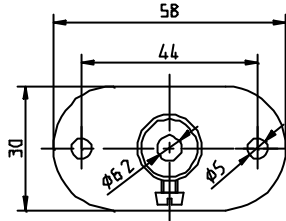
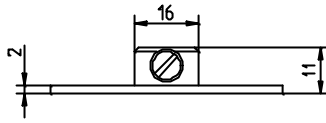
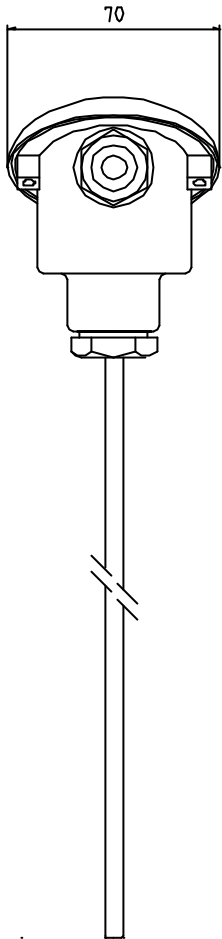

Konsole BR6.2

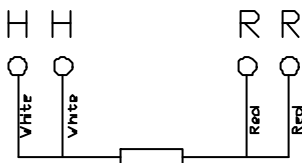
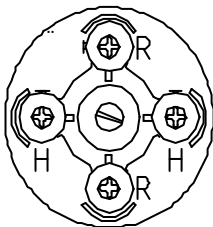
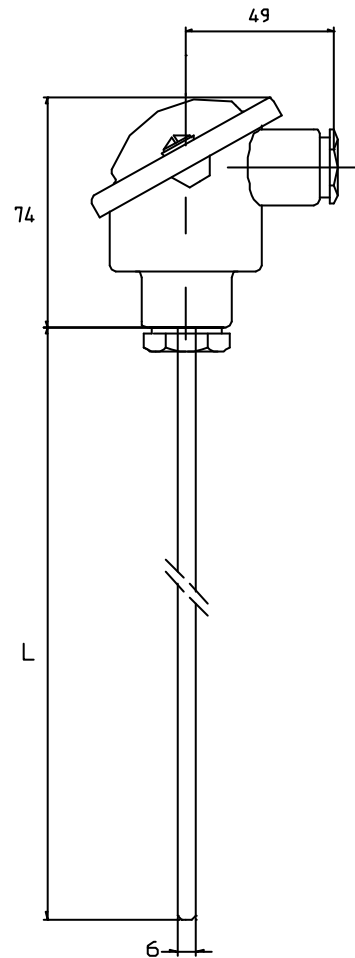

4-tråds koppling

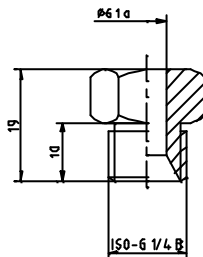
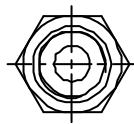

Klämringskoppling

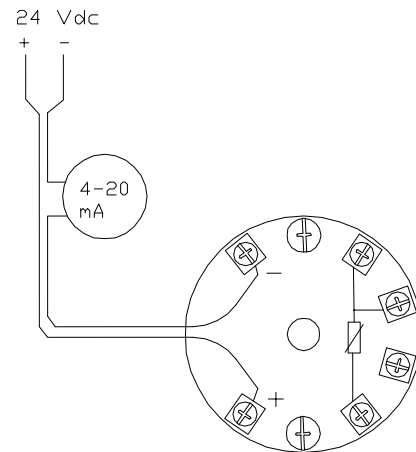

Temperatur transmitter

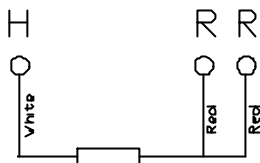

3-tråds koppling